

Application

Widely used in commercial and industrial applications.

To cover any width of opening, any number of panels can be used.

To accommodate different building designs, panels can slide to one or both sides.

Where panels are fitted externally, a canopy is recommended.

Panel Specification

Track System:	Single Run 200
For Individual Panels:	
Max Panel Height	3600mm
Max Panel Weight (Nylon Tyre)	150kg
Max Panel Weight (Steel Tyre)	200kg
Min Panel Thickness	35mm

For ease of operation it is recommended that the panel width should not exceed 75% of panel height.

Timber panels for interior use can be of flush construction or glazed. Timber panels for industrial applications should be framed, ledged and braced. Metal panels should be constructed of box section, channel or angle framing, well braced and clad with flat or corrugated sheets.

Hardware Specification

Track:	200
Material	2mm Galvanised Steel
Standard Lengths	4000mm and 6000mm

Brackets:	
Face fitted steel	1S/200
Soffit fitted steel	2S/200
Face fitted stainless steel angle	1SS/250
Double face fitted S/S angle	5SS/250

Hangers (2 per panel):		Steel Tyre
Timber panels - angle fitting	52KN	
Timber panels - plate fitting	57KN	57KS
Metal panels - angle frame	56KN	56KS
Metal panels - box frame	56KLN	56KLS
Metal panels - plate fitting	57KN	57KS

Hanger supplied with timber screws, fixing plate and precision bearings. Vertical adjustment is simple and positive. Nylon tyre wheel hangers should not be used on installations involving temperatures exceeding 80°C.

Steel tyre hangers have solid steel wheels and are fitted with ball race bearings. All steel parts are zinc plated.

Guides:	
Timber panels - plate fitting	106RB/94
Multiple panels	102W/94SS

Channels:	
Aluminium	94A Mill or clear anodised
Aluminium & Polypropylene	94PPA Mill or clear anodised
Brass	94B
Standard lengths	2000mm, 3000mm, 4000mm and 6000mm

Accessories:	
Door Stop	200DS
Flush Pulls	401
Flush Bolts	456

Flush bolts and flush pulls are available in (PVD) PVD Brass, (SN) Satin Nickel & (PN) Polished Nickel

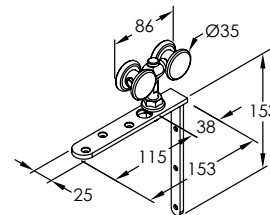
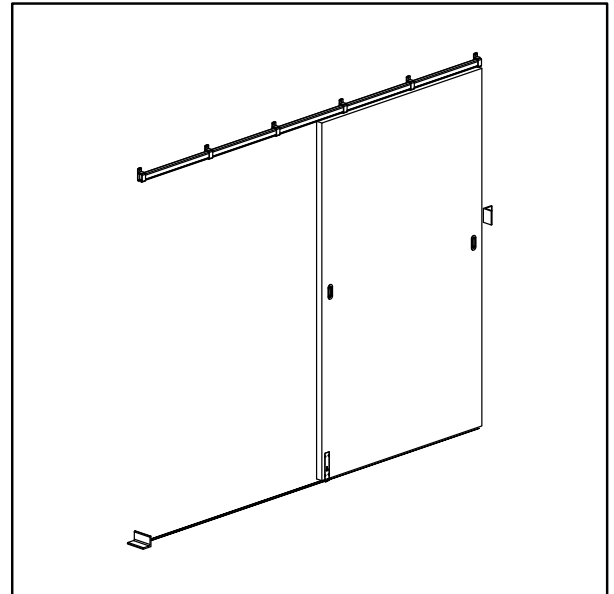

No. 52KN HANGER

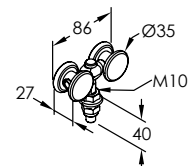

No. 56KN or No. 56KS HANGER

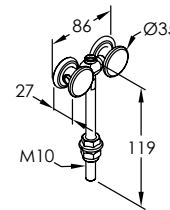

No. 56KLN or No. 56KLS HANGER

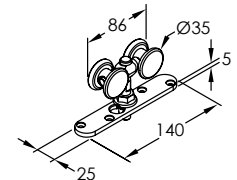

No. 57KN or No. 57KS HANGER

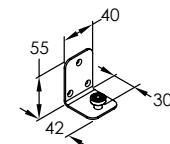

No. 102W/94SS GUIDE

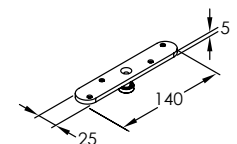

No. 106RB/94 GUIDE

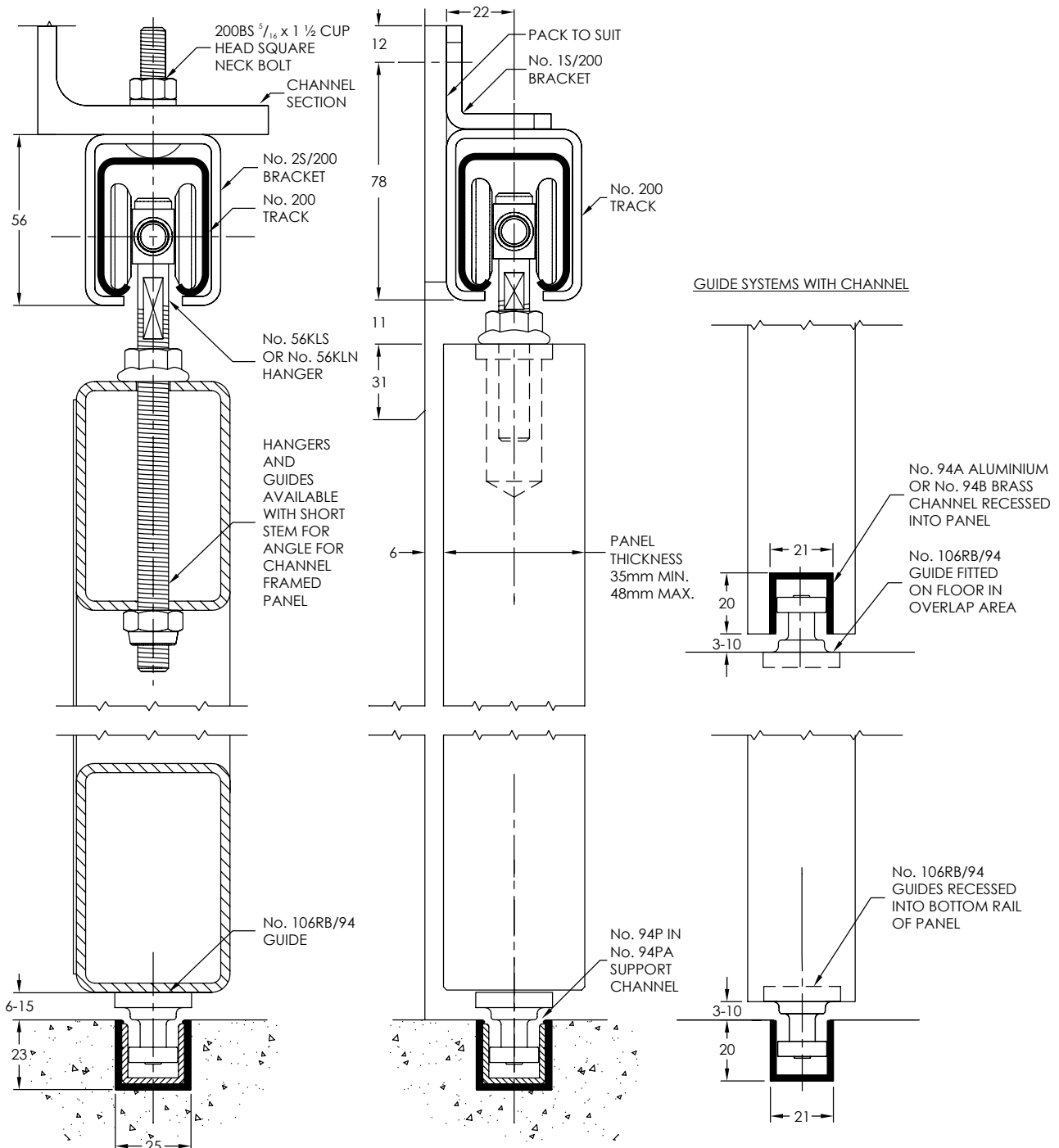

HARDWARE PLACEMENT
FRONT VIEW (PANEL SLIDING INSIDE)

BRACKET PLACEMENT
16mm TO CENTRE OF FIRST BRACKET FROM EACH END, THEN A BRACKET APPROXIMATELY EVERY 400mm CENTRES.

STANDARD TRACK LENGTH	2000	3000	4000	6000
No. OF BRACKETS	6	9	11	16

