

Application

Brio's Zero Clearance Glass is an ideal internal system for residential and commercial applications for easy operation of toughened glass panels.

Designed to achieve minimal clearances of just 4.5mm between top edge of the glazing rail and underside of the track.

Zero Clearance Glass 180 hangers are cast 316 stainless steel with precision bearings.

Panel Specification

Track System:

For Individual Panels:

Max Panel Height	3000mm
Max Panel Width	1500mm
Max Panel Weight	180kg
Panel Thickness	10-12mm

Zero Clearance Glass 180

Standard Packs

Packs include hangers, door stops, glazing rail, glazing bead, guide and handle.

Pack No.

ZG180-12/1
ZG180-15/1

Max Panel Width

1200mm
1500mm

Hardware Specification

Track:

Material 180 Aluminium Clear Anodised
Standard lengths 2000mm, 3000mm, 4000mm and 6000mm

Accessories:

Handle 535G

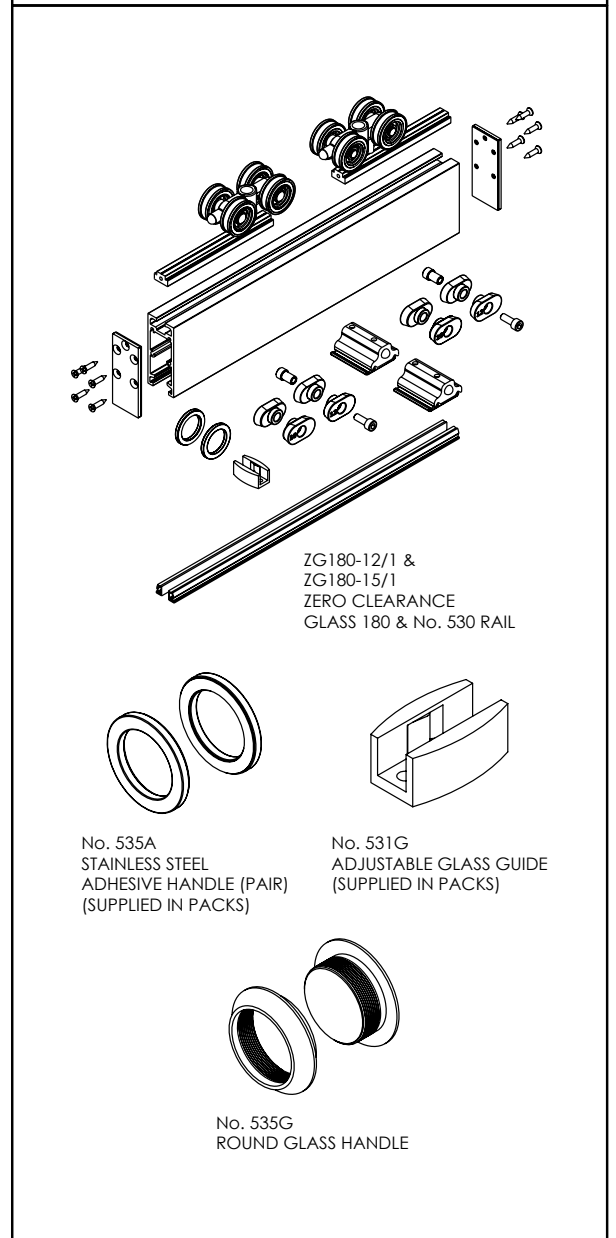
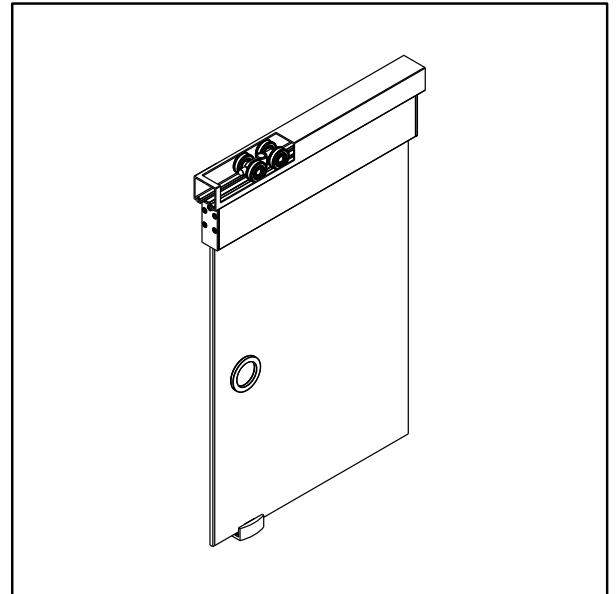

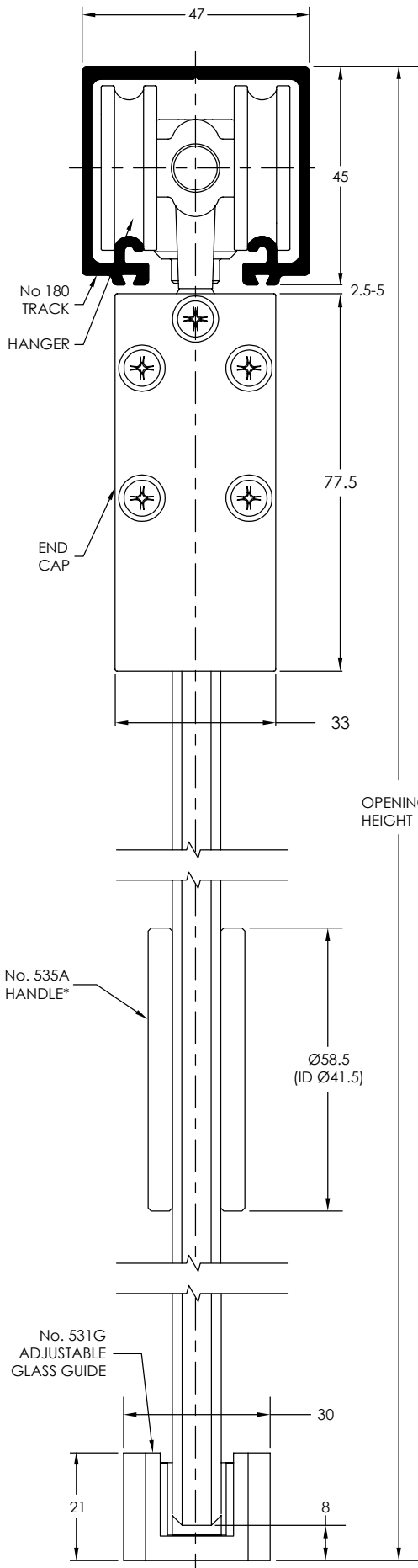

OPENING HEIGHT (H)

TRACK FIXING CENTRES
20mm FROM EACH END, 400mm MAXIMUM

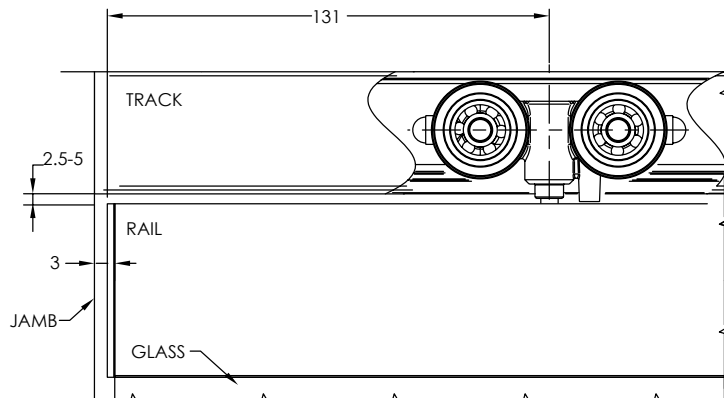

GLASS PREPARATION FOR ALL HANGERS
CUT GLASS SIZE = OPENING HEIGHT (H) - 60mm
FOR PANELS ≤ 1000mm 2 FIXINGS REQUIRED
*FOR PANELS ≥ 1001mm 3 FIXINGS REQUIRED

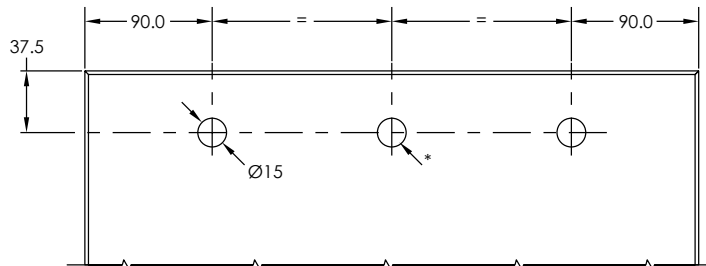

INSTALLATION

1. CHOOSE FITTING FOR 10mm OR 12mm GLASS.
2. CLAMP INTO PRE-DRILLED HOLES USING 5mm ALLEN KEY
3. INSERT CLAMPS INTO RAIL

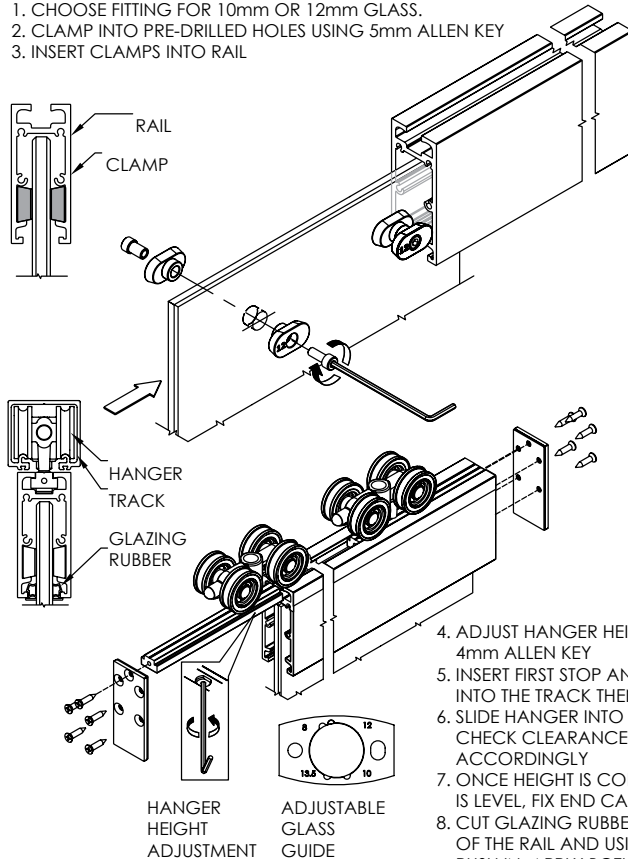

4. ADJUST HANGER HEIGHT USING 4mm ALLEN KEY
5. INSERT FIRST STOP AND HANGERS INTO THE TRACK THEN THE LAST STOP
6. SLIDE HANGER INTO THE RAIL. DOUBLE CHECK CLEARANCE AND ADJUST ACCORDINGLY
7. ONCE HEIGHT IS CORRECT AND PANEL IS LEVEL, FIX END CAPS ONTO THE RAIL
8. CUT GLAZING RUBBER TO THE LENGTH OF THE RAIL AND USING DETERGENT PUSH IN. APPLY BOTH SIDES
9. PREPARE GUIDE ACCORDING TO THICKNESS OF GLASS. FIX GUIDE TO OVERLAPPING AREA OF OPENING

* FOR No. 535G ROUND GLASS HANDLE, MACHINE A Ø50 HOLE TO FIT HANDLE