

Application

For built-in panels sliding on a double track, i.e. wardrobes and cupboards in residential, heavy duty applications.

Easy height adjustment.

Silent operation - nylon wheeled bearing hangers and aluminium track.

Panel Specification

Track System:	Wardrobe Double 50
For Individual Panels:	
Max Panel Height	2400mm
Max Panel Width	900mm
Max Panel Weight	50kg
Panel Thickness	16-35mm

Lightly framed timber panels or panels made from medium density fibreboard (MDF) must have provision for hangers to be screwed securely to the back face of the panels

Standard Sets and Packs

Sets comprise of top track, hangers, door stop(s), sawcut guide(s), all timber screws and fitting instructions.

Set No.	Panel width	Track Length	Hardware for
WD50-12/2	600mm	1200mm	2 panels
WD50-15/2	750mm	1500mm	2 panels
WD50-18/2	900mm	1800mm	2 panels
WD50-24/3	800mm	2400mm	3 panels

Pack No.	Description
WD50-2PK	2 panel pack of fittings only, without track
WD50-3PK	3 panel pack of fittings only, without track

Hardware Specification

Track:	52
Material	Aluminium, Mill
Standard lengths	1200mm, 1500mm, 1800mm, 2400mm, 3000mm, 3600mm and 4800mm

Hangers (2 per panel):	550, 551, 552
-------------------------------	---------------

Nylon tyred ball race bearing with zinc plated plates face fitted to the back of the panel. Vertical adjustment 10mm.

Door Stop:	28N
-------------------	-----

Nylon safety door stop prevents fingers being jammed on bi-passing panels.

Guide:	55GD
---------------	------

Guide in white nylon, comes in two parts that fit on both sides of the panel. The guide is floor mounted.

Accessories:	
Alternative Guide	101N

The nylon guide is designed to slide through a 20mm deep by 5mm wide sawcut in the bottom rail of the panel. The guide is fitted on the floor at the edge of the opening in the overlap area. The guide has lateral adjustment.

Channel and Guide	81 and 113N/81
-------------------	----------------

113N/81 guides in white nylon. For heavy duty applications or where more than 3 panels are required per opening. 81 channel, aluminium, available in 1200mm, 1500mm, 1800mm, 2400mm, 3000mm and 3600mm lengths.

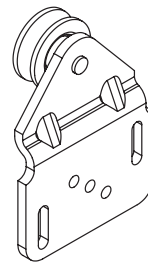
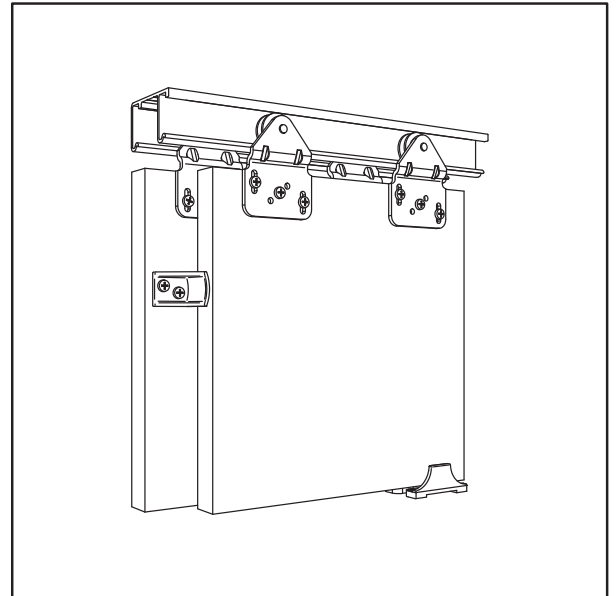

No. 550 HANGER

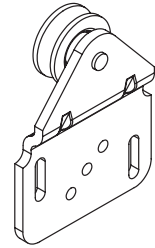

No. 551 HANGER

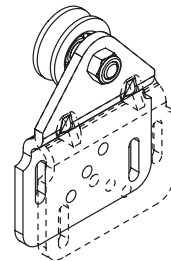

No. 552 HANGER

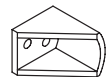

No. 28N DOOR STOP

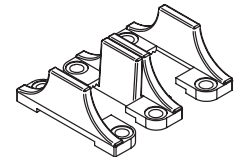

No. 55GD GUIDE

ALTERNATIVE GUIDES

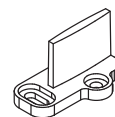

No. 101N GUIDE (INCLUDED IN SETS AND PACKS)

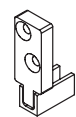

No. 113N/81 GUIDE AND No. 81 CHANNEL

PANEL THICKNESS	19	22	25	29	32	35
DIMENSION 'A'	4	16	19	23	26	29
DIMENSION 'B'	9	23	20	16	13	10
DIMENSION 'C'	0	4	7	11	14	17

PANELS 19MM THICK & UNDER

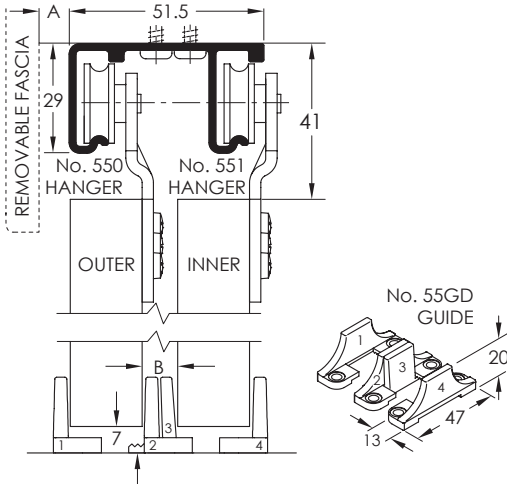

PANELS 20MM TO 35MM THICK

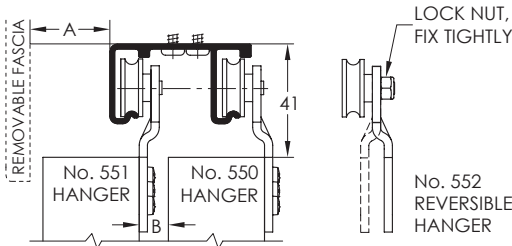

TRIPLE LINE PANELS 35MM THICK & UNDER

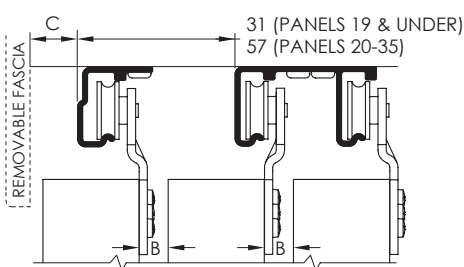

NOTE: 22-35 THICK PANEL HANGER ORIENTATION SHOWN. FOR 16-19 THICK PANELS HANGER ORIENTATION TO BE AS SHOWN IN FIRST IMAGE.

ALTERNATIVE GUIDES

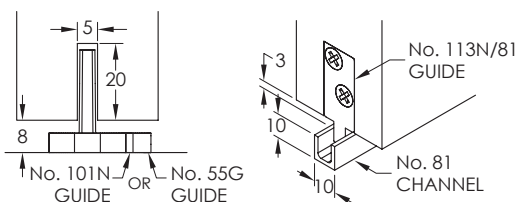

INSTALLATION INSTRUCTIONS

1 Prepare Panels

Panel width = (Opening width / No. of Panels) + 5 to 10mm (Overlap)
 Panel height = Opening height less 53mm.
 Track length = Opening width
 For more than three panels use continuous channel and guide.

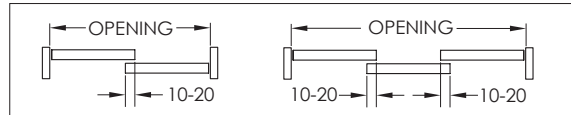

2 Fit Track

Panel thickness determines dimension 'A' - see table. Fit track 'A' mm from the outside edge of a level and flat lintel. For triple line systems fit tracks as shown, use dimension 'C' from table.
 For panels over 35 thick use multiple 51 tracks.

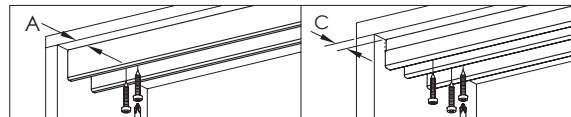

3 Fix Hardware to Panel

Panels 19mm thick and less - fit blue plate hangers to inner panel. All other thicknesses, the blue hangers are fitted to the outer panel. Align the plate shoulder with the top edge of the panel. Screw 2 screws only in the centre of the slotted holes to give ±5mm vertical adjustment.

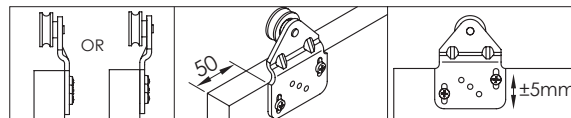

4 Fix Panels & Adjust

Working inside to out. Hook panels onto track. Adjust hangers to obtain maximum floor clearance. When panels are hanging plumb and square, fit a 3rd screw into one of the hanger locating holes.

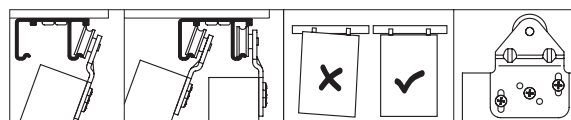

5 Fit Guide

With panels hanging plumb fix guide to overlapping area of opening. Screw holes under panel. Slide to panels one side of opening and secure guide with one screw in the visible holes. Position components 2 & 3 of guide to dimension 'B'. Slide panels to opposite side and fit remaining screws.

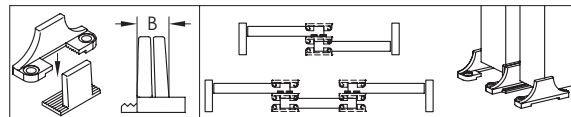

6 Fit Door Stop

Position door stop on inner face of outer panel, 2/3 of panel height. Positioned to prevent finger pull from passing the edge of adjacent panel (not supplied).

