

Application

Suitable for interior sliding frameless glass or panels of mirror, plastic or veneered timber. Used for showcases, bathroom cabinets, hatches and reception counter windows.

The double run system for bi-passing panels uses anodised aluminium and bottom rollers. Vertical adjustment possible when panels are in situ.

Panels can be secured by a specially designed cylinder lock.

Panel Specification

Rail System:	Glassroll 30
For Individual Panels:	
Max Panel Weight	30kg
Max Panel Area	2.5m ²
Panel Thickness	6mm

Panels must be 6mm thick to accept the appropriate glazing strip.

Standard Sets

Sets comprise of top guide with woolpile, two glazing rails with PVC glazing strip, bottom rail, four bottom rollers, four end caps, two finger pulls, all timber screws and installation instructions.

Opening width	Set No.
1200mm for 2 panels	GR30-12/2
1500mm for 2 panels	GR30-15/2
1800mm for 2 panels	GR30-18/2

Hardware Specification

Top Guide - with woolpile	526W
Glazing Rail	524
Bottom Rail	525
Material	Aluminium
Finish	Satin anodised
Standard Lengths	4500mm

Glazing Strip: 509

Made from clear P.V.C to secure a 6mm panel in the glazing rail.

Bottom Roller: 521

521: Nylon housing with side access adjustment and nylon wheel with a precision bearing for 30kg panels.

End Cap: 523

Finger Pull: 27

Designed to fit into a 22mm diameter hole in the panel and is made from stainless steel

Accessories:
Cylinder Lock: 527A
Supplied with 2 keys, keyed alike.

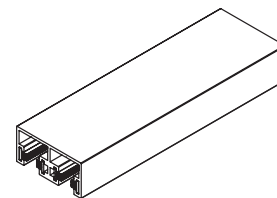
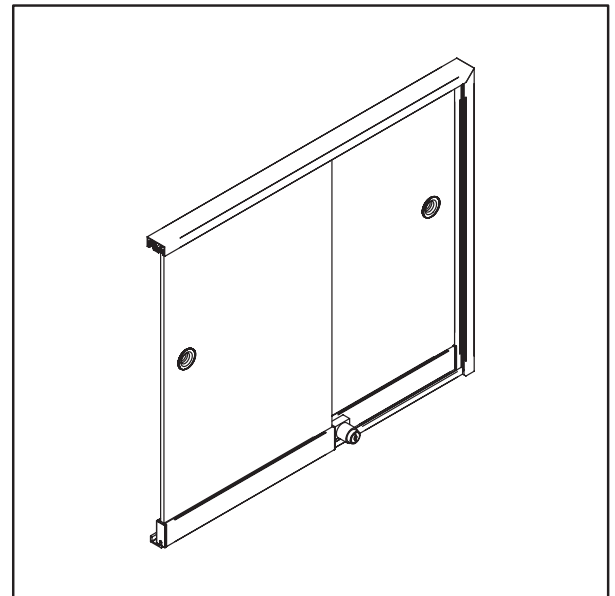

No. 526W
TOP GUIDE
WITH WOOLPILE

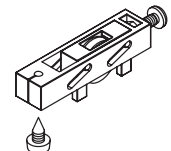

No. 521
ROLLER

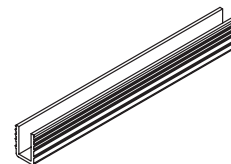

No. 509
GLAZING STRIP

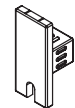

No. 523
END CAP

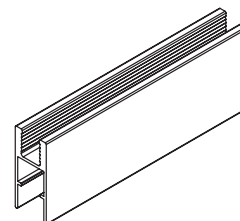

No. 524
GLAZING RAIL



No. 27
FLUSH PULL

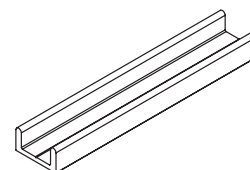

No. 525
BOTTOM RAIL

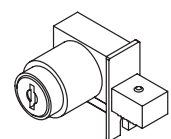

No. 527A
LOCK

INSTALLATION INSTRUCTIONS

GLASS & EXTRUSIONS

Glass Height	H (Opening Height) - 37mm
Glass Width	W (Opening Width - 7mm + X (Overlap))
	2
No. 526W	W (Opening Width)
No. 525	W (Opening Width)
No. 524	Glass Width
No. 509	Glass Width

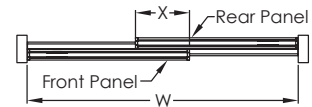

System closed: X = Glass overlap
2 equal sized panels
Note: Countersunk holes required in No. 525 and No. 526W

PANEL ASSEMBLY

1. Ensure rollers height adjustment screw is fully engaged
2. Slide rollers into each end of glazing rail
3. Place rollers 28mm from edge of glazing rail
4. Lock off rollers with clamp screw
5. Place each panel into frame

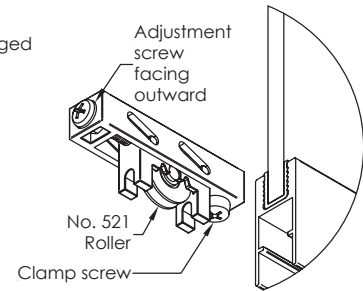
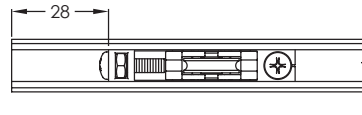

ADJUSTMENT

1. Using a screw driver, wind back the adjustment screw to lower that side of the glass panel
2. Once panels are level and square with frame, insert end Cap into glazing rail at both ends

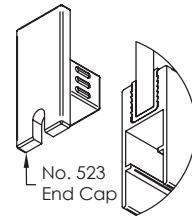
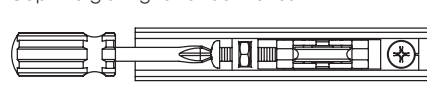

SECURITY

1. Prepare glass, No. 526W, No. 525 and No. 509 as described above (X must equal 72mm minimum)
2. Cut No. 524 glazing rail to glass width
3. Drill Ø9mm hole through the glazing rail of the rear panel

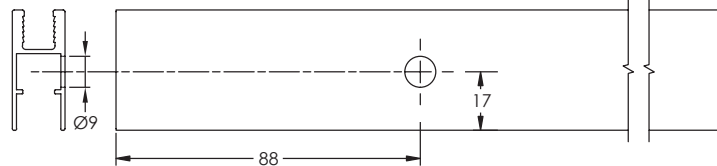

4. Insert rollers and lock off into position in glazing rail, place panels into frame and adjust as described above
5. Remove front panel and insert lock into glazing rail (lock can be handed by removing fasteners and flipping arm from left to right)
6. Using grub screw secure lock into position
7. Return front panel to frame and insert end caps (1 will have been replaced by lock)
8. Secure panels as described above
9. Create 8 spacers (4mm high x 6mm wide) and screw 4 into each guide channel of No. 526W

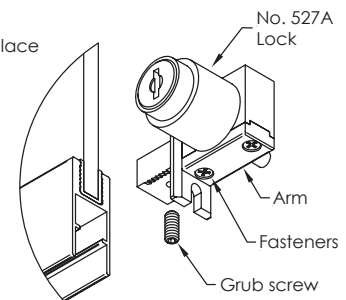

PICTURE FRAME / 4 SIDES

1. Additional length of No. 526W required, length = 2 x H, as well as length = W, mitre at 45° to create frame

Glass Height	H (Opening Height) - 37mm
Glass Width	W (Opening Width - 18mm + X (Overlap, min 72mm))
	2
No. 525	W (Opening Width) - 30mm
No. 524	Glass Width - 9
No. 509	Glass Width - 9

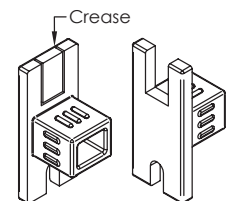

2. Remove cut out from 2 end caps by running a stanley knife through the crease
3. Glass of rear panel to overhang glazing rail by 9mm on the right, glass of front panel to overhang glazing rail by 9mm on the left
4. Assemble system as described above

