

Application

For timber sliding panels on interior and exterior applications.

Designed for straight sliding partitions or fully glazed patio doors. Also suitable for flush panelled construction.

The bottom roller design is suited to applications where the supporting structure or lintel is insufficient for the weight of the panel or where headroom is limited.

To cover the width of opening, any number of panels can be used on single or multiple lines of rail. Panels can slide to one or both sides.

Where fitted externally, a canopy is recommended to protect the top guide channel, brackets and top guide rollers.

Panel Specification

Rail System:

For Individual Panels:	Timberoll 300
Max Panel Height	3300mm
Max Panel Weight	300kg
Min Panel Thickness	44mm

Panels must be constructed with bottom rails of at least 175mm depth to accommodate the concealed, mortised, bottom rollers. Panel weight is carried on the floor permitting the use of a light overhead structure.

Hardware Specification

Top Guide Channel:

Heavy Duty	900A Aluminium with safety lip
Material	Aluminium
Finish	Clear Anodised
Standard Lengths	2000mm, 3000mm, 4000mm and 6000mm.

Top Guide Brackets:

For single line - face fitted	1SS/250 Stainless Steel
For double line - face fitted	5SS/250 Stainless Steel
Constructed from cast 316 Stainless Steel, fit at 400mm maximum centres.	

Top Guide Rollers (2 per panel):

Top Plate fitting	61SS/900 (for 900 Top Guide Channel)
Cast 316 Marine grade stainless plate with double nylon rollers with lateral adjustment to prevent rattle.	

Bottom Rollers (2 per panel):

	916SS
The 916SS roller is constructed of stainless steel with a precision bearing for ease of use and smooth, maintenance-free rolling.	

Bottom Rail:

	917
Material	Brass
Standard Lengths	2000mm, 3000mm and 4000mm.
Bottom Rail is drilled and countersunk for screwing to timber floor.	

Interlocker:

	924
Material	Aluminium
Finish	Clear Anodised (CA), Black Anodised (BLK) and Anodised Bronze (BZ)
Standard Lengths	4800mm or pair of 2400mm lengths (to suit typical 2400mm high panel)

Interlocker is drilled and countersunk, comes with brush seal.

Accessories:

Door Collector - multiple panels	924-DC
Flush Bolt	456
Flush Pull	401
Frame Seal	AQ21

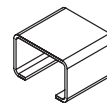
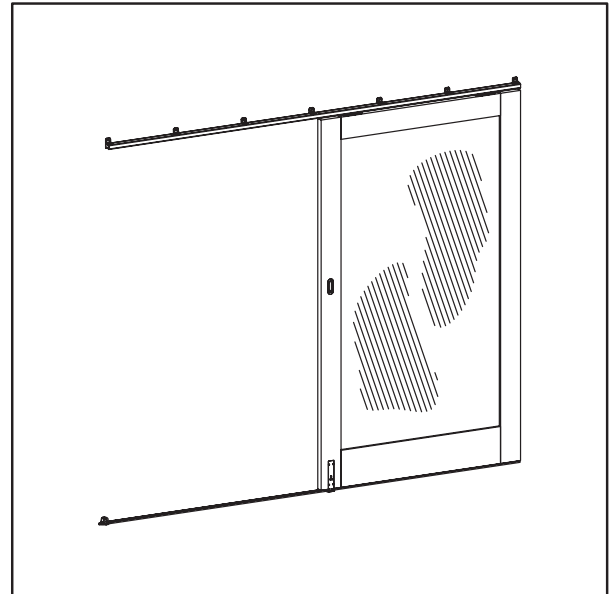

No. 900A
GUIDE CHANNEL

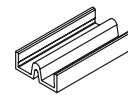

No. 917
BOTTOM RAIL



No. 924
INTERLOCKER



No. 1SS/250
BRACKET

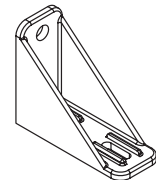

No. 5SS/250
BRACKET

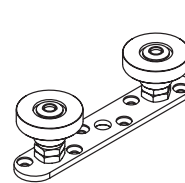

No. 61SS/900
TOP GUIDE ROLLER

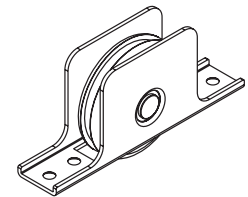

No. 916SS
BOTTOM ROLLER

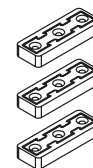

No. 924-DC
DOOR COLLECTOR

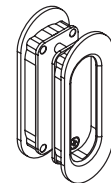

No. 401
FLUSH PULL

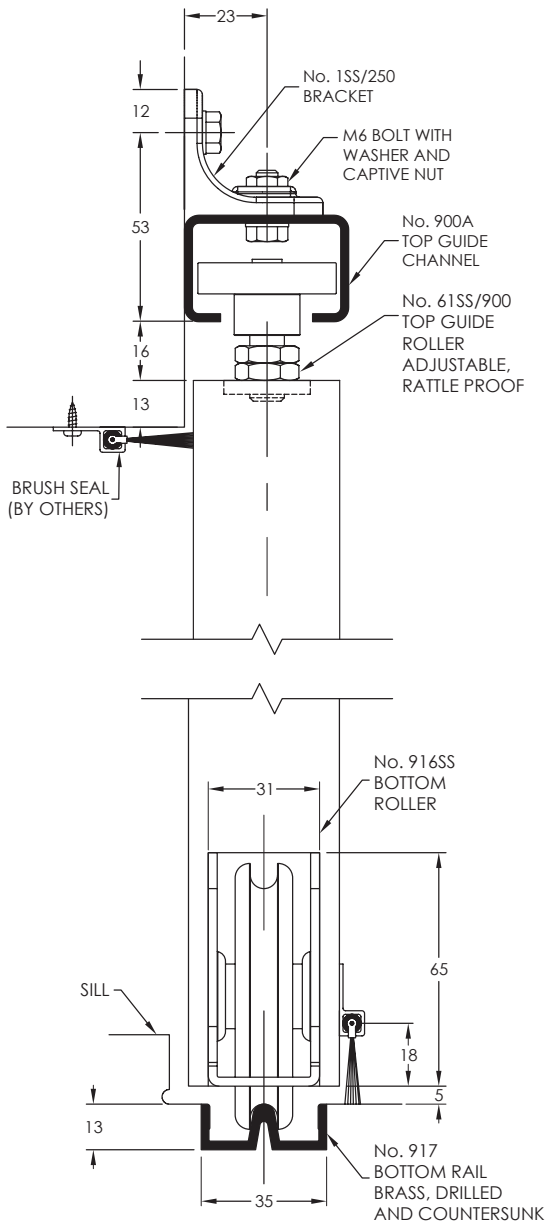

OPTIONS

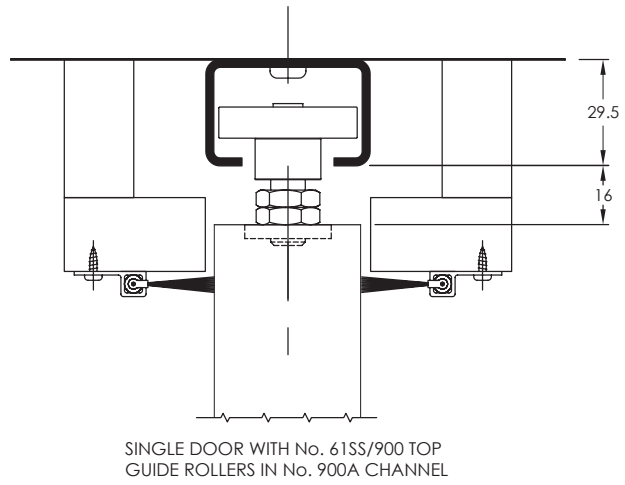

BRACKETS

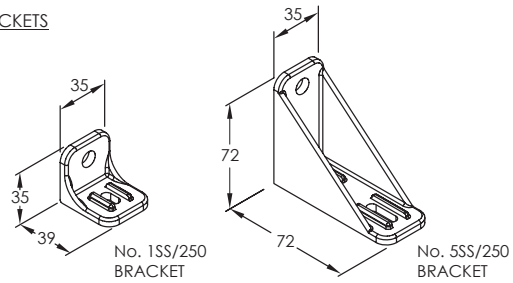

No. 916SS BOTTOM ROLLER

